

# 17 - REMOTE CONTROL OPERATION INSTRUCTIONS

## A. REMOTE ICON IDENTIFICATION

Remote:

Skytech Premium Transmitter Model AF-4000TSS02 comes standard with the fireplace.

Touch Screen LCD

Takes four (4) AAA batteries (included)

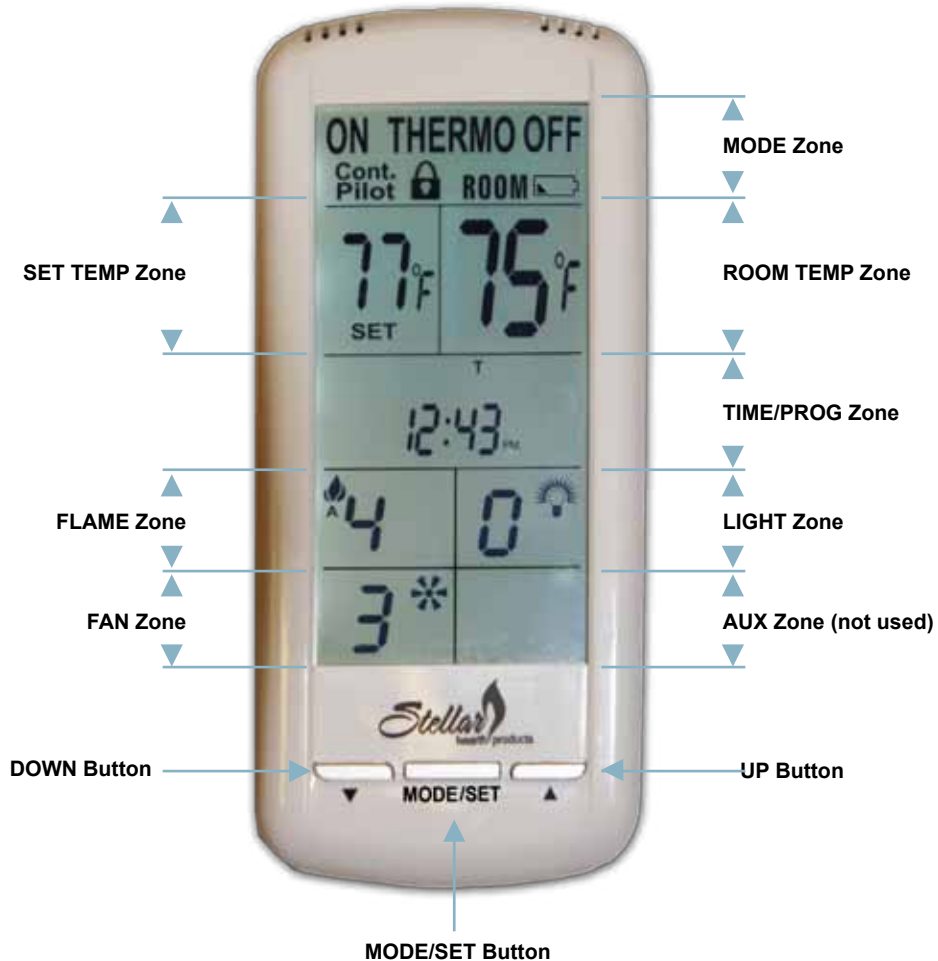

Figure 17A

## B. REMOTE CONTROL INFORMATION



### IMPORTANT ELECTRICAL WARNING AND INFORMATION

Electrical wiring must be installed by a licensed electrician.

- Do NOT wire 110V to wall switch.
- Uninterrupted or continuous power is required at all times in IPI systems EXCEPT when using battery back-up.
- Incorrect wiring will override IPI safety lockout and may cause an explosion.
- Disconnect 110V before servicing

A double receptacle box cover and (3) wire nuts are supplied in fireplace components packet to be used when hardwiring to electrical box located under firebox on right side of fireplace.



### IMPORTANT ELECTRICAL WARNING AND INFORMATION

THIS SYSTEM GOES THROUGH A CALIBRATION MODE WHEN SWITCHING FROM 'ON' TO 'THERMO' TO 'OFF' MODES, CREATING A HUMMING SOUND WHICH IS A NORMAL PART OF OPERATION.

## 17 - REMOTE CONTROL OPERATION

### C. CONTINUOUS PILOT - FOR VERY COLD CONDITIONS

The IPI gas control system has the option of a continuous (standing) pilot feature. This allows you to change from a spark-to-pilot system to a standing pilot system during cold weather conditions. By having the pilot on continuously, the firebox will remain warm and a draft is established in the vent, allowing the main burner to turn on with less air-flow disruption.

When continuous pilot mode is activated, the pilot will spark and light. When fireplace is turned OFF, the pilot will remain lit when main burner has been turned OFF.

This pilot feature can be activated or de-activated by the hand held remote control transmitter or the switch on the module. Instructions on following page.

### D. OPERATION USING BATTERY POWER



#### IMPORTANT NOTE

**When operating fireplace in this capacity, the only function available is flame modulation.**

1. This fireplace has an optional battery operation if electrical power is lost (see Page 51, Figure 16B). Position battery pack with four "AA" size batteries installed between valve and front of fireplace. This is the coolest location under firebox, ensuring longer battery life.
2. Next locate the fireplace's control module (see Page 51, Figure 16A). The "Remote/Off" slide switch on the back side of the module must be slid into the "Off" position to allow the battery pack to function.
3. Once accomplished, the fireplace can be turned fully on or off using the On/Off Rocker Switch located on the front bracket of the valve assembly below.

**NOTE: When in Battery Mode, the only functions available are turning the fireplace on or off.**

**No flame adjustments are available nor will the remote control be available for the fan, ember lights, thermostat, etc.**

### E. MATCHING SECURITY CODES

Before matching security codes make sure 120V AC is connected and powered to fireplace, and hand held remote control is installed with (4) AAA batteries. It may be necessary to program main control module to LEARN the security code of the hand held remote control upon initial use, if batteries are replaced, or if a replacement remote control is purchased from your dealer.

1. When matching security codes, be sure slide button on main control module is in REMOTE; the code will not "LEARN" if slide is in OFF.
2. Program main control module to LEARN a new security code by pushing in LEARN button on main control module using a pencil point for 2 seconds and let go (you should hear a series of 'beeps' letting you know module is ready to learn a new code).
3. Immediately press MODE button on hand held remote control (you should hear four 'beeps' in rapid succession in main control module, indicating remote control's code has been programmed into the main control module). When an existing main control module is introduced to a new hand held remote control, the new security code will overwrite the old one.

If it ever becomes necessary to clear the memory from the hand held remote control, simply push and hold the LEARN button for 10 seconds (you should hear three long beeps in succession). You may now follow steps outlined above to 'RE-LEARN' security codes.

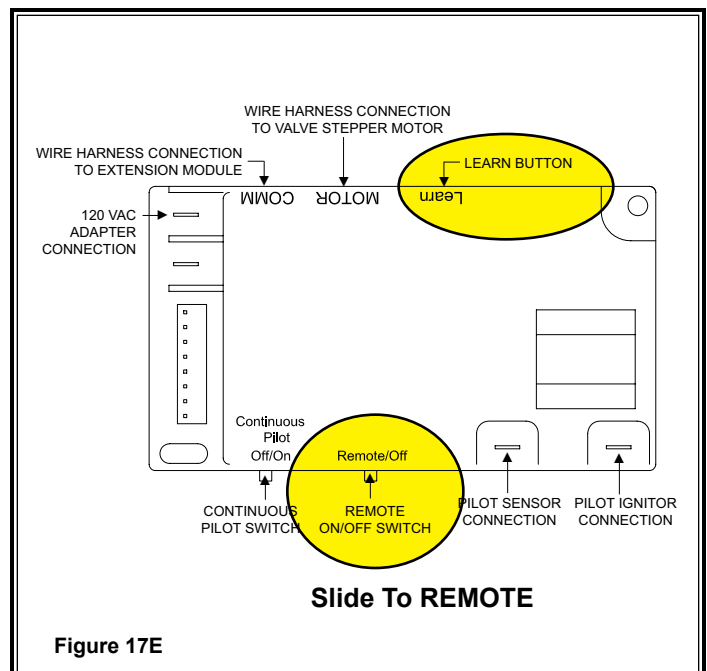

## 17 - REMOTE CONTROL OPERATION

### F. INITIAL SET-UP

Plug Extension Module and AC Adaptor into receptacles.

Install (4) AA batteries into battery compartment of **Backup Battery Pack**, making sure batteries are installed in proper direction. Position between valve and front of stove. A Velcro strip has been attached to help secure in place.

The **Hand Held Remote** operates on (4) AAA batteries. We recommend always using ALKALINE batteries to extend battery life and improve operational performance.

### G. GAS TYPE CONVERSION

Press and hold **Learn** Button on Main Control Module for 20 seconds. A beep will be heard letting you know the procedure has been completed.

- If converting from NAT to LP gas: (1) one second long beep
- If converting from LP to Nat gas: (3) three second long beep

Continue with gas type conversion by following instructions included with gas conversion kit.

### H. CELSIUS/FAHRENHEIT CONVERSION

Press UP and DOWN keys simultaneously to choose Celsius or Fahrenheit.

### I. IMPORTANT SAFETY FEATURE

This system has a maximum room temperature limit of 90° F (32° C) in both manual and thermostat modes. When room temperature is at or above this point the system will shut down and the hand held remote control will read **OFF**. If you turn the system **ON** when room temperature is still at or above this temperature, the system will again shutdown after 2 minutes when room temperature is recalculated.

### J. CONTINUOUS PILOT FEATURE

Activation of this optional feature is accomplished by pressing the **MODE/SET** button and **ARROW UP** buttons simultaneously for 5 seconds. The continuous pilot icon will appear on the **LCD** screen. Pressing **both buttons again** for 5 seconds will de-activate this feature.

This feature can also be activated via **CONTINUOUS PILOT** switch on Main Control Module.

### K. CHILDPROOF FEATURE

Activation of this optional feature is accomplished by pushing **MODE/SET** button and **ARROW DOWN** buttons simultaneously for 5 seconds. The **childproof icon** will appear on the LCS screen. When a transmitter button is pressed the icon will flash on screen, but no signal will be transmitted. Pressing and holding these same two buttons again for more than 5 seconds will de-activate this function.

This feature controls only manual functions of the hand held remote, automatic functions (thermostat mode) will not be affected.



Figure 17J



Figure 17K

# 17 - REMOTE RECEIVER INFORMATION

## L. MANUAL MODE

This remote can be manually or thermostatically operated.

Press **MODE/SET** button for manual **ON**. The flame icon will appear on the **LCD** screen. Press **MODE/SET** button again to put the control into **THERMO** mode. Pressing **MODE/SET** again will turn fireplace **OFF**.



### IMPORTANT NOTE

The **MODE/SET** button operates in a series that will cycle from **ON** to **THERMO** to **OFF**.



Figure 17L

## M. FAN MODE

This remote will operate the fan, allowing for (6) different speed levels. Press the **MODE/SET** button. The **FAN** icon (\*) will light up. Press the **FAN** icon on the **LCD** screen, then the **UP** or **DOWN ARROWS** to select the desired fan speed level. Press the **MODE/SET** button to set or wait 15 seconds and the control will automatically accept the new setting, exit function setting mode and **LCD** display will return to normal view.



### IMPORTANT NOTE

**Delayed ON/OFF** - The fan will not turn on until fireplace has been burning for 5 minutes and will not turn off for 12 minutes after fireplace has been turned off.

**EXCEPTION:** If fireplace is turned back on during 12 minute off-delay time frame, the fan will remain on. This applies to **MANUAL** and **THERMO** modes.

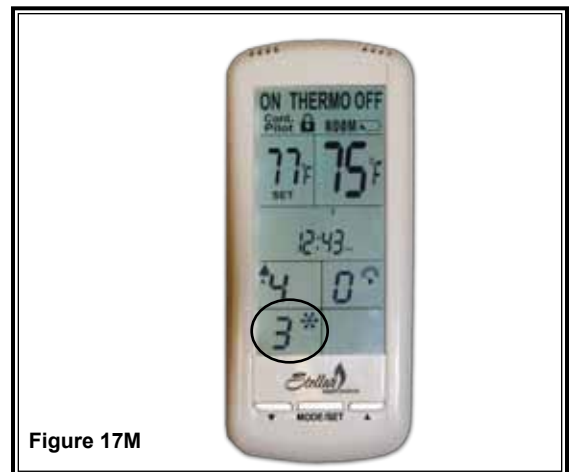

Figure 17M

## N. LIGHTING MODE

This remote will operate the lights, allowing for (6) different light levels. When **LIGHT** button is pressed, Press the **MODE/SET** button. The **LIGHT** icon will appear on the **LCD** screen. Press the **LIGHT** icon on the screen. Press **UP** or **DOWN** buttons to select desired light level. Press the **MODE/SET** button or wait 15 seconds and the control will automatically accept the new setting, exit function setting mode and **LCD** display will return to normal view.



### NOTE

The fireplace does not have to be burning to operate the lights.

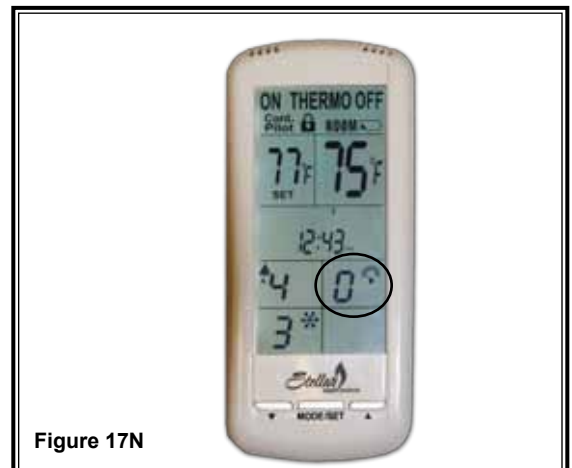

Figure 17N

## 17 - REMOTE RECEIVER INFORMATION

### O. FLAME MODE

This remote will operate the flame, allowing for (6) different flame height levels. Press the MODE/SET button. The FLAME icon will appear on the LCD screen. Press the FLAME icon on then screen, then ress **UP** or **DOWN** buttons to select desired flame level. Press the MODE/SET button to set or wait 15 seconds and the control will automatically accept the new setting, exit function setting mode and **LCD** display will return to normal view.

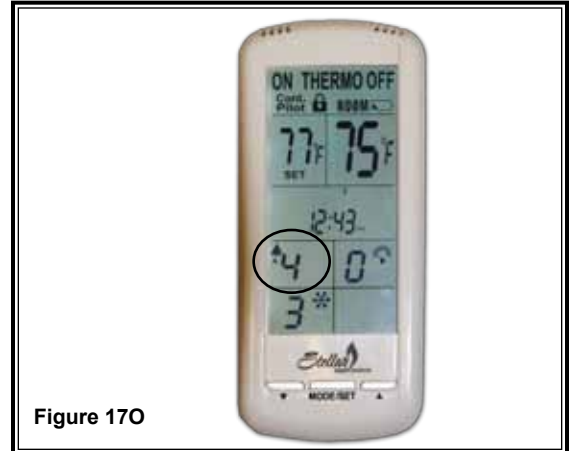

Figure 17O



#### IMPORTANT NOTE

The fireplace will initially light at the highest level. After 5 seconds the flame will adjust to last chosen level before fireplace was turned OFF. This applies to **MANUAL** and **THERMO** modes.

### P. THERMO (THERMOSTATE) MODE

This remote feature allows you to thermostatically control the fireplace when hand held remote is set to **THERMO** mode.

Set Temperature Range: 45°F (7°C) to 90°F (32°C).

Set remote to **THERMO** mode by pressing **MODE/SET** button twice. "**ON THERMO**" will appear on the LCD screen. Touch the SET TEMP ZONE on the screen, then press the UP or DOWN ARROW buttons to the desired temperature. Within 5 seconds fireplace will operate to that set temperature.

Set temperature will only appear when **THERMOSTAT MODE** is activated, but is implemented in all **MODES** with the exception of **MANUAL MODE**.

To exit **THERMO** mode, press the **MODE/SET** button. This also shuts the fireplace OFF.

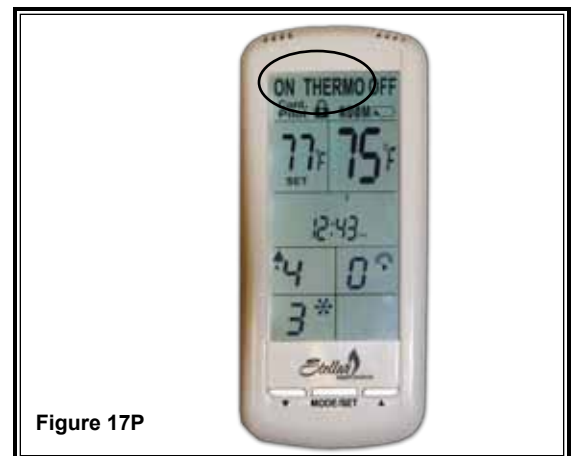

Figure 17P



#### IMPORTANT NOTE

The flame height can adjust up to (6) different height levels according to amount of heat required. This range however is dictated by the Flame Level setting (see previous page). When desired temperature is met, the fireplace will shut off until more heat is required.



#### IMPORTANT NOTE

When in **THERMO** mode the fireplace will not turn on until room temperature falls below **SET TEMPERATURE**.

## 17 - REMOTE RECEIVER INFORMATION

### Q. SET THE DAY AND TIME DISPLAY

The current day of the week and time of day will be continuously displayed in the TIME/PROG Zone (except during SET UP operations).

The day of the week will be displayed as one of the following: S, M, T, W, T, F, S.  
The Time of day will be in 12-hour AM, 12-hour PM format with midnight being displayed as 12:00am.

**DAY** - Press and hold the MODE Zone or the MODE/SET button for 5 seconds. Press the UP or DOWN buttons to adjust to the desired day of the week. Press the MODE/SET button to set or wait 15 seconds and the control will automatically accept the day, then enter the hour of day adjustment.

**HOUR**: Press the UP or DOWN buttons to adjust the hour of the day. The time will advance in 1-hour increments; AM and PM will change when the hour advances to 12:00 midnight and 12:00 noon respectively. Once the desired time of day is displayed, press the MODE/SET button to set or wait for 15 seconds and the control will automatically accept the hour, then enter minute of hour adjustment.

**MINUTE(S)**: Press the UP or DOWN buttons to adjust the minute of the hour. The time will advance in 1-minute increments. Press the MODE/SET button once the desired minute is reached or wait 15 seconds and the control will automatically accept the new time, and exit DAY/TIME Setup and return to normal screen operation.

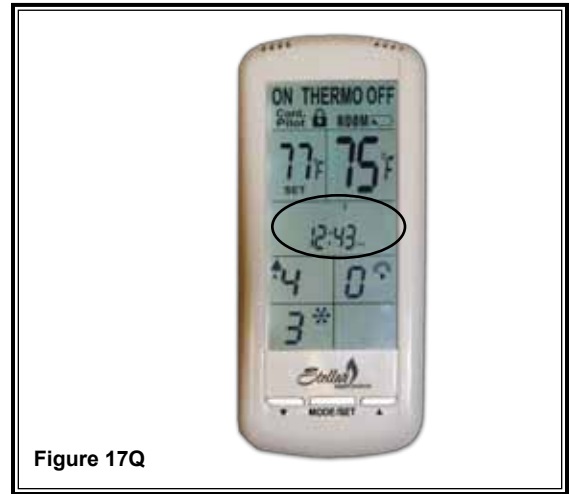

Figure 17Q

### R. SYSTEM OPERATION WITHOUT HANDHELD REMOTE

This system is designed to operate with the hand held remote or a thermostat, but in the unlikely event that it is required to be operated without the hand held remote or a thermostat, follow this simple procedure.

Slide **REMOTE /OFF** switch on main control module to **OFF**. The fireplace can now be lit and shut off by use of the ON/OFF rocker switch located next to the module.



#### IMPORTANT NOTE

**When operating fireplace in this capacity, the only function available is burner operation on HI.**

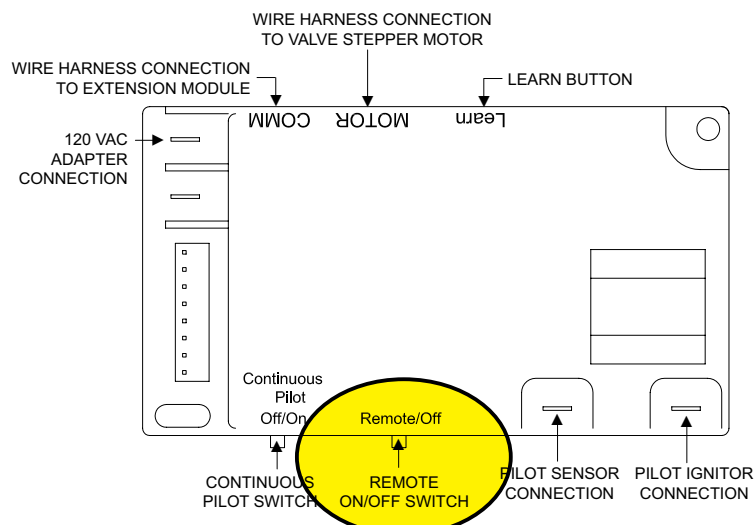

Figure 17R